



Strengthening Teaching Competences in Higher Education  
in Natural and Mathematical Sciences  
[www.tecomp.ni.ac.rs](http://www.tecomp.ni.ac.rs)

Co-funded by the  
Erasmus+ Programme  
of the European Union



# Употреба EPSON уређаја за унапређивање процеса наставе на групи ботаничких предмета

**Др Снежана Бранковић**  
Природно-математички факултет  
Универзитет у Крагујевцу



## Top/Side/Rear

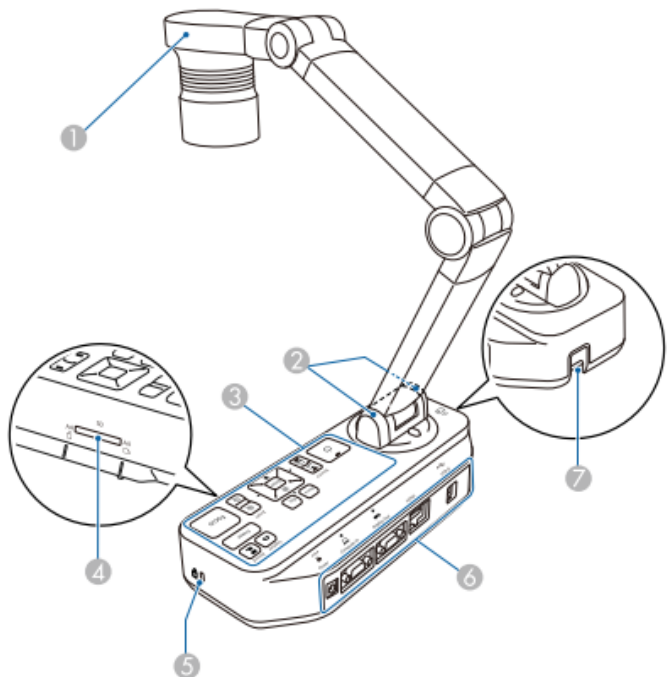

Name	Function
① Camera head	"Camera Head" <a href="#">p.12</a>
② Remote receiver	Receives signals from the remote control.
③ Control panel	"Control Panel" <a href="#">p.13</a>
④ SD card slot	Lets you save and display images on an SD card. "Displaying Saved Images as a Slideshow" <a href="#">p.30</a>
⑤ Security slot	The security slot is compatible with the Microsaver security system manufactured by Kensington.
⑥ Interface	"Interface" <a href="#">p.14</a>

Name	Function
⑦ Security cable installation point	Lets you attach a commercially available security cable to lock the document camera in place.

## Camera Head

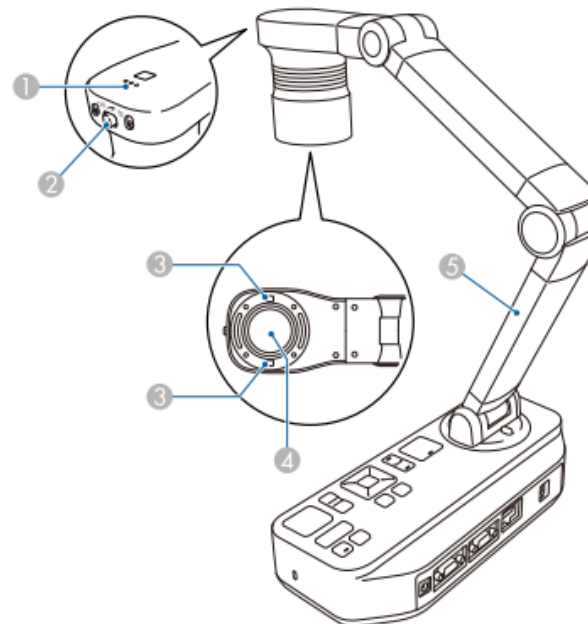

Name	Function
① Microphone	Captures sound when you record a video.
②  Lamp switch	Changes the LED lamp status in three steps: bright, dim, and off.
③ LED lamp	Provides additional light when there is not enough light on your document.
④ Camera lens	Captures the image.

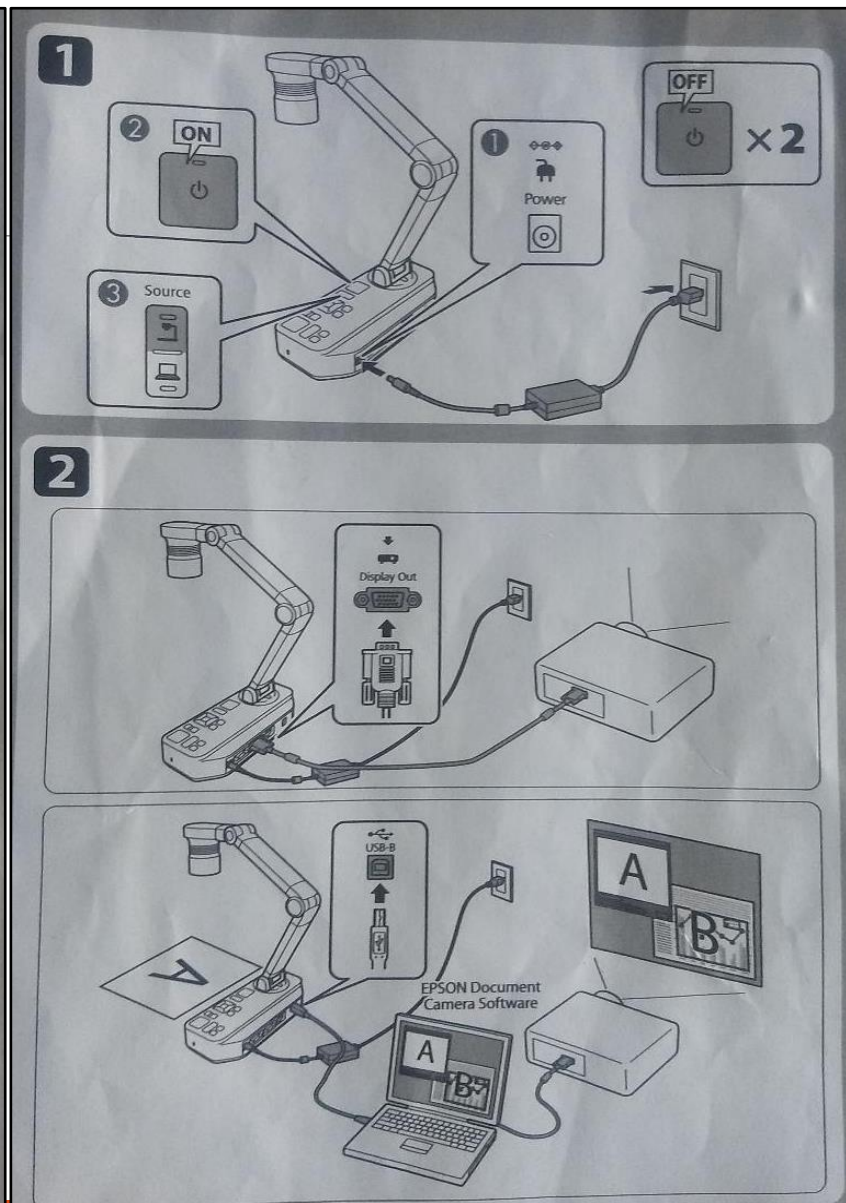
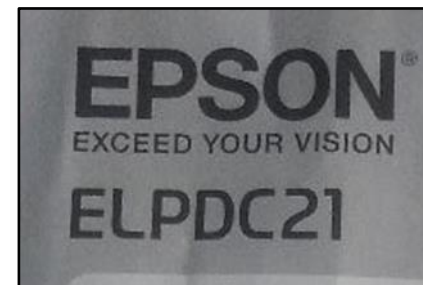



Name	Function
5 Camera arm	Extends or retracts to adjust the height of the camera head.

**Attention**  
Do not rub the lens with harsh materials or subject it to shock, as it can be easily damaged. Use a soft cloth to gently wipe the lens.

### Control Panel

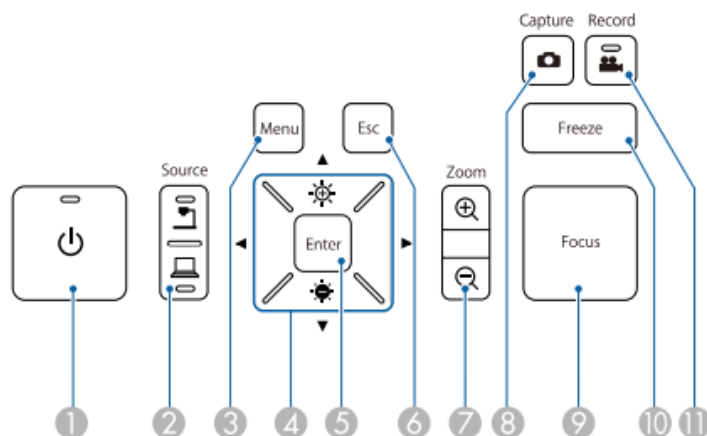

Name	Function
1 [Power] power button	Turns the document camera on or off.
2 [Source] button [SD Card] [Laptop]	Switches the output image to the device connected to the Display Out port. [SD Card]: Projects images (live or on an SD card) from the document camera. [Laptop]: Projects images from a computer connected to the Computer In port.

Name	Function
3 [Menu] button	Opens and closes the menu.
4 [Up] [Down] [Left] [Right] buttons	When the menu screen is displayed, pressing these buttons selects menu items and setting values.
[Brightness] buttons	Adjusts the brightness of the image if pressed while projecting images from the document camera.
[Left] [Right] buttons	Adjusts the focus of the image if pressed while projecting images from the document camera.
5 [Enter] button	<ul style="list-style-type: none"> <li>When the menu is displayed, pressing this button confirms the current item.</li> <li>Displays the <b>SD Card</b> menu and images on the SD card if pressed while projecting live images.</li> <li>"Displaying a Slideshow (SD Card Viewer Function)" p.33</li> </ul>
6 [Esc] button	Stops the current function. When the menu is displayed, pressing this button moves to the previous menu level.
7 [Zoom] button [+] [-]	Enlarges or reduces the image without changing the projection size.
8 [Capture] button [Camera]	Captures still images. "Saving Images" p.31
9 [Focus] button	Focuses the image automatically. The document camera cannot focus on objects that are approximately 10 cm (4 inches) or less from the surface of the camera lens.
10 [Freeze] button	Freezes live images. Press the button again to resume projection.
11 [Record] button [Video]	Starts and stops video recording.

## Interface

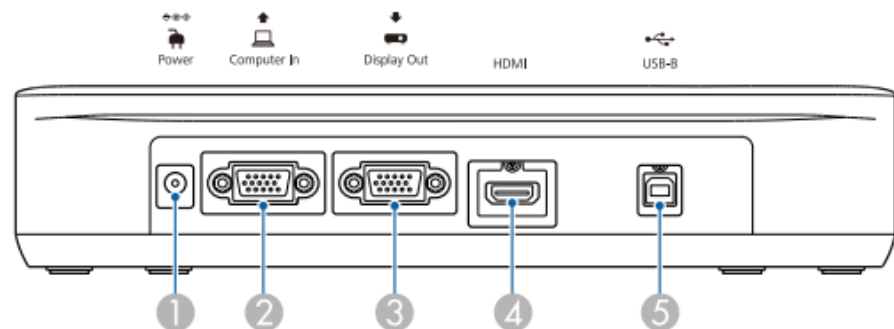

	Name	Function
①	Power (AC adapter/DC In) port	Connects the supplied power cord and adapter.
②	Computer In port	Inputs image signals from a computer.
③	Display Out port	Outputs images to image devices such as projectors.
④	HDMI port	Outputs images and audio to a video device that is compatible with HDMI signals.
⑤	USB-B (TypeB) port	Connects the document camera to your computer with the USB cable supplied. By using the software supplied, you can operate the document camera from a computer.

## Base

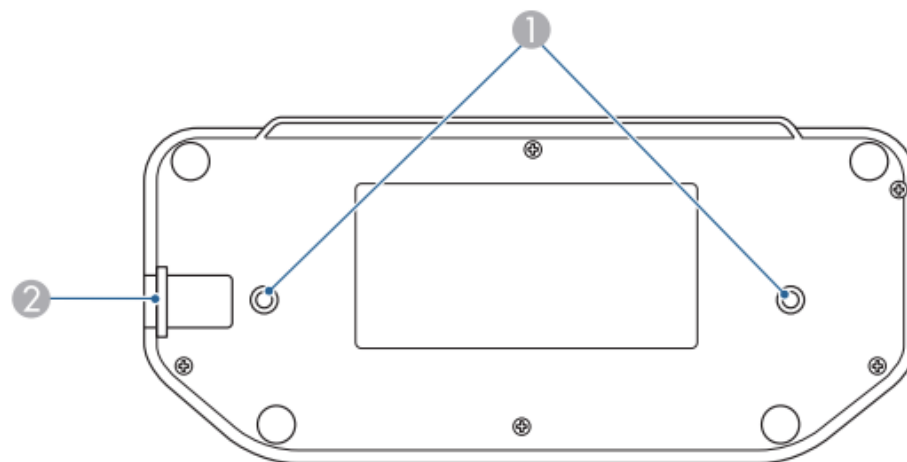

	Name	Function
①	Mounting points	You can attach the document camera to a table, cart, or stand with commercially available M4 bolts. You can thread them to a maximum depth of 9 mm (0.35 inch). <div style="border: 1px solid black; padding: 5px; margin-top: 10px;"> <b>Attention</b>                      Fasten the bolts securely but do not overtighten them. Do not use adhesives.                 </div>
②	Security cable installation point	Lets you attach a commercially available security cable to lock the document camera in place.

## Remote Control

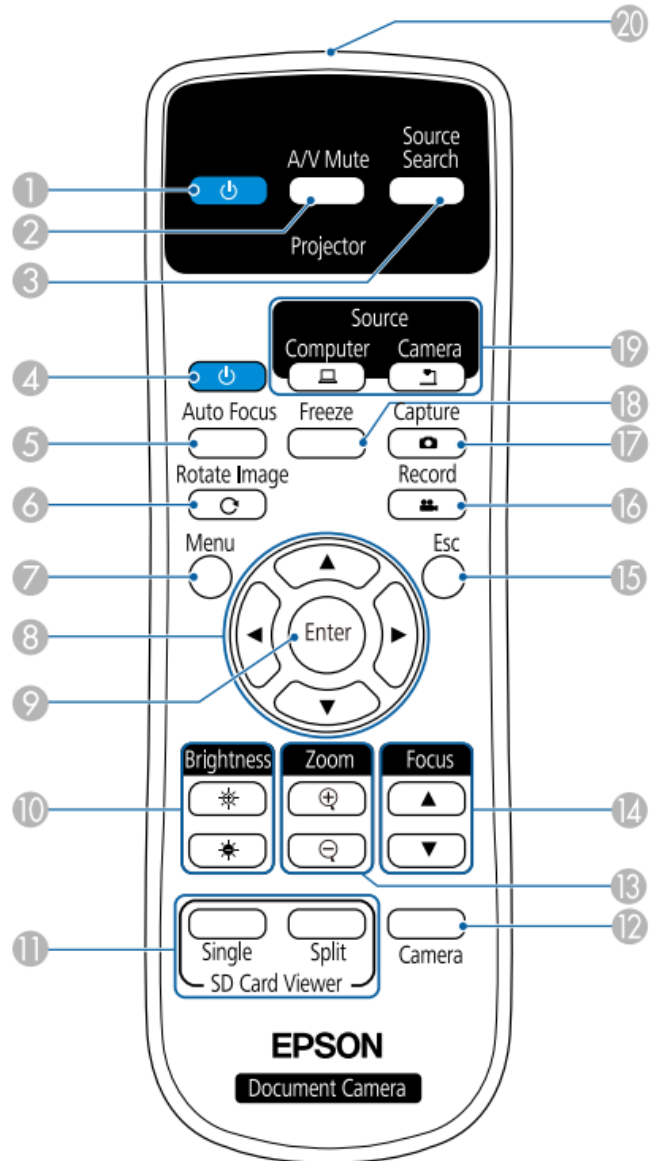

## Projector operations

	Name	Function
1	[⏻] power button	When used with an Epson projector, turns the projector on or off.* You cannot operate the document camera with this button.
2	[A/V Mute] button	Turns the video and audio of an Epson projector on or off.*
3	[Source Search] button	Changes the input source connected to an Epson projector.*

\* This is not supported by some projectors. For more details, contact your local dealer or the nearest service center provided in this guide.

☛ "Epson Projector Contact List" p.52

## Document camera operation

	Name	Function
4	[⏻] power button	Turns the document camera on or off. You cannot operate a projector with this button.
5	[Auto Focus] button	Focuses the image automatically. The document camera cannot focus on objects that are approximately 10 cm (4 inches) or less from the surface of the camera lens.
6	[Rotate Image] button [↻]	Lets you turn an image upside-down.
7	[Menu] button	Opens and closes the menu.
8	[▲][▼][◀][▶] buttons	When the menu screen is displayed, pressing these buttons selects menu items and setting values.
9	[Enter] button	<ul style="list-style-type: none"> <li>When the menu is displayed, pressing this button confirms the current item.</li> <li>Displays the <b>SD Card</b> menu and images on the SD card if pressed while projecting live images.</li> </ul>

## Remote Control Buttons

	Name	Function
10	[Brightness] button [☀] [☾]	Adjusts the projected image brightness.
11	[SD Card Viewer] button	Projects images and movies on the SD card as a slideshow. Press the [Single] button to display the image on one screen, and press the [Split] button to display two images on the left and right. ☛ "Displaying a Slideshow (SD Card Viewer Function)" p.33
12	[Camera] buttons	Projects live images from the document camera.
13	[Zoom] button [⊕] [⊖]	Enlarges or reduces the image without changing the projection size.
14	[Focus] button [▲] [▼]	Adjusts the focus of the image manually.
15	[Esc] button	Stops the current function. When the menu is displayed, pressing this button moves to the previous menu level.
16	[Record] button [📹]	Starts and stops video recording.
17	[Capture] button [📷]	Captures still images.
18	[Freeze] button	Freezes live images. Press the button again to resume projection.
19	[Source] button [💻] [📷]	Switches the output image to the device connected to the Display Out port. [💻]: Projects images from a computer connected to the Computer In port. [📷]: Projects images (live or on an SD card) from the document camera.
20	Remote control light-emitting area	Outputs remote control signals.

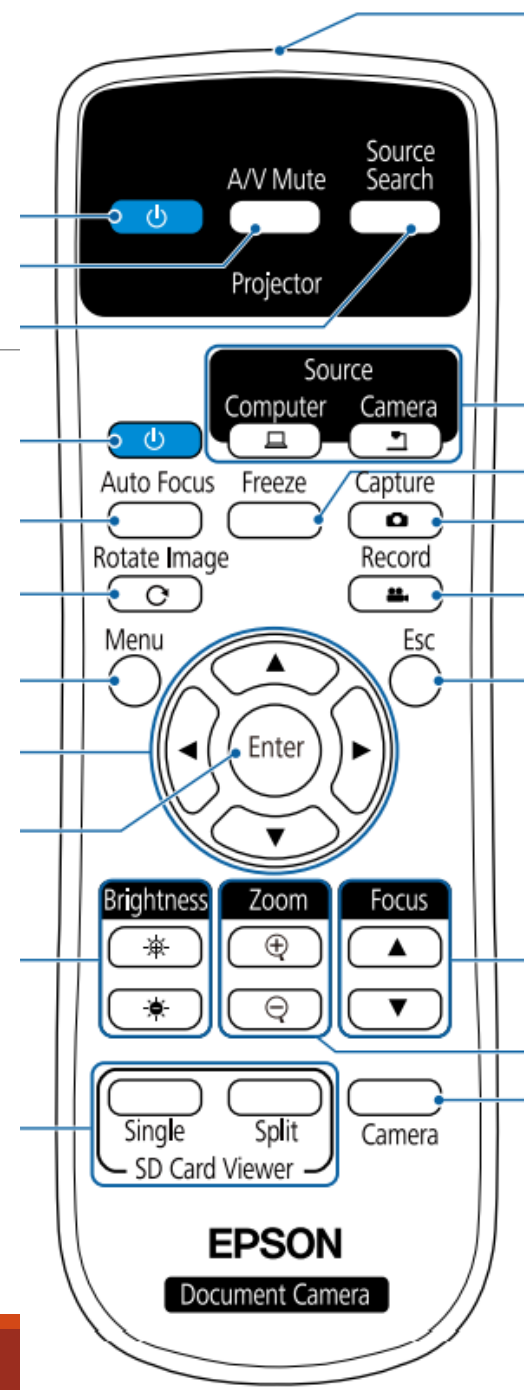









## Za Windows



Dvaput pritisnite ikonu "  My Computer" na radnoj površini.

Odaberite ikonu "  Document CD-ROM", a zatim pritisnite

desnom tipkom miša i odaberite "Open".

Dvaput pritisnite mapu "  Manual".

Dvaput pritisnite mapu "  Croatian".

Mapa "  Manual" i datoteka "  Manual.pdf"

sadrže priručnik koji možete kopirati i otvarati s diska računala.

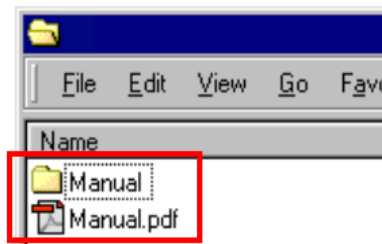



## Za Macintosh

Dvaput pritisnite ikonu "  Document CD-ROM" na radnoj površini.

Dvaput pritisnite mapu "  Data".

Dvaput pritisnite mapu "  Manual".

Dvaput pritisnite mapu "  Croatian".

Mapa "  Manual" i datoteka "  Manual.pdf" sadrže

priručnik koji možete kopirati i otvarati s diska računala.

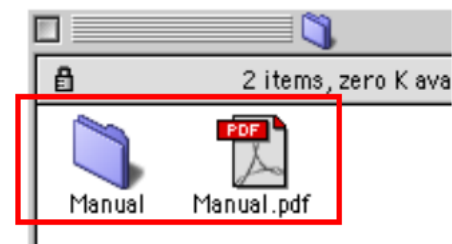

# Vodič za Easy Interactive Tools Ver.4.1



Način rada s bijelom pločom za pisanje



1



## Početni zaslon

Prikazuje početni zaslon.

2



## Spremi

Prikazani zaslon sprema u formatu JPG, BMP, PNG, PDF ili EIT. Sve su stranice spremljene u Način rada s bijelom pločom za pisanje. Ako spremite u PDF ili EIT formatu sve se stranice spremaju kao jedna datoteka.

Kada koristite cijeli zaslon u Način rada s bijelom pločom za pisanje [  ] odaberite **Spremi** ili **Spremi kao**.

Lokaciju spremanja možete promijeniti na kartici **Spremi** na zaslonu Postavke. Ako želite naknadno uređivati datoteku spremite je u formatu EIT.



Ako otvorite EIT datoteku na drugom računalu s drugačijom razlučivosti zaslona, neki dijelovi crteža možda se neće prikazati.

 "Kartica Spremi" [str.23](#)

3



## Prethodna stranica

4



## Sljedeća stranica

Tijekom Način rada s bilješkama: Premještanje trenutno prikazane stranice za jedno mjesto prema dolje.

Tijekom Način rada s bijelom pločom za pisanje: Premještanje trenutno prikazane stranice za jedno mjesto prema dolje.

5



## Ostali alati

Prikazuje ploču s alatima.

 "Funkcije ploče s alatima" [str.17](#)

6



## Kamera za dokumente

Prikaz slike s kamere za dokumente povezane s računalom. Više informacija o korištenju zaslona Kamera za dokumente potražite u sljedećem poglavlju.

 "Zaslon Kamera za dokumente" [str.19](#)

\* Ova funkcija podržava Epson kameru za dokumente. Za popis podržanih kamera za dokumente obratite se najbližem trgovcu na Popisu kontakata za Epson projektor u Priručniku za uporabu projektoru ili kamere za dokumente.

7



## Način rada s bilješkama

Započinje Način rada s bilješkama.

8



## Način rada s bijelom pločom za pisanje

Započinje Način rada s bijelom pločom za pisanje.

9













## Izlaz

Prekida Easy Interactive Tools.



Možete promijeniti veličinu za Traka naredbi klikom na [  ] u Načinu rada s bilješkama. Kad je odabrano **Kamera za dokumente**, format zaslona za Traka naredbi optimiziran je za radnje kamere za dokumente.

Sljedeće funkcije dostupne su samo u Način rada s bijelom pločom za pisanje.



- 10  **Novo**  
Stvara novu datoteku.
- 11  **Otvori**  
Otvora prethodno spremljene EIT ili .avi datoteke za Windows i .mov datoteke za OS X.
- 12  **Popis stranica**  
Prikazuje zaslon popisa stranica.  
Kad interaktivna olovka napusti popis stranica, popis se automatski smanjuje na desni ili lijevi dio zaslona. Popis stranica ponovno će se prikazati kad interaktivnu olovku premjestite u smanjeno područje.  
Ako odaberete [  ], mijenja se u [  ], a popis stranica fiksira se na tom mjestu.  
Odaberite [  ] ako želite zatvoriti popis stranica.
- 13  **Nova stranica**  
Dodaje novu stranicu nakon trenutno prikazane.
- 14  **Dupliciraj stranicu**  
Duplicira trenutno prikazanu stranicu i dodaje je nakon trenutne stranice.
- 15  **Izbriši stranicu**  
Brisanje trenutno prikazane stranice.
- 16  **Prikaz prozora**  
Prebacuje zaslon crteža između punog zaslona i prikaza prozora.

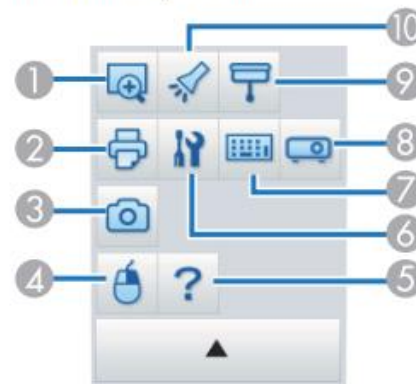

## Funkcije ploče s alatima

Kad odaberete [  ] s Traka naredbi prikazuje se sljedeća ploča.

Način rada s bilješkama



- 1  **Povećaj područje**  
Prikazuje uvećani prikaz slike. Povucite kursor za označavanje područja koje želite povećati.
- 2  **Ispis**  
Ispisuje trenutno prikazan zaslon. Ispisuju se sve stranice ako koristite Način rada s bijelom pločom za pisanje. Stranice koje želite ispisati možete izabrati na zaslonu postavki ispisa.
- 3  **Snimiti**  
Snima trenutno prikazani zaslon i kopira ga u međuspremnik. Međuspremnik čuva samo jednu stavku.  

 Prilikom prikaza prozora u Način rada s bijelom pločom za pisanje, napomene izvan okvira prozora nisu kopirane.
- 4  **Klik desnom tipkom**  
(To je dostupno samo tijekom postupaka s mišem u Način rada s bilješkama.)  
Pritisak olovke samo jednom funkcionira kao desni klik, a potom se vraća na normalan klik.
- 5  **Pomoć**

Način rada s bijelom pločom za pisanje









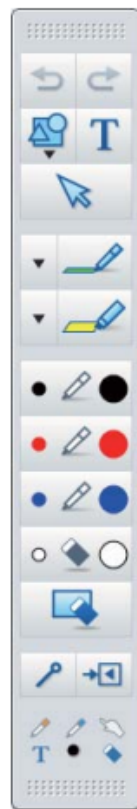
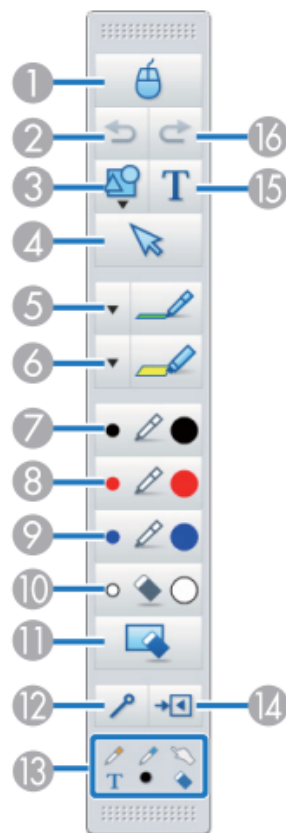



S Alatna traka za crtanje moguće je odabrati sljedeće funkcije.









Način rada s bilješkama

Način rada s bijelom pločom za pisanje



- 1  **Miš**  
(To je dostupno samo tijekom Način rada s bilješkama.)  
Prebacuje se iz postupaka za crtanje u postupke za rad miša, a kursor na zaslonu računala postaje standardni kursor miša. Interaktivnom olovkom možete klikati i povlačiti po projiciranoj slici.  
Za povratak u postupke za crtanje ponovno kliknite ovu ikonu.

- 2  **Poništi**  
Poništavanje prethodne radnje.
- 3  **Oblici**  
Odaberite željeni oblik među ponuđenim oblicima. Možete odabrati i boju te debljinu crte oblika.
- 4  **Odaberi**  
Odaberite sadržaj crteža ili umetnutu sliku a zatim provedite postupke poput premještanja stavke ili prilagodbe veličine.
- 5  **Olovka**  
Prebacivanje na olovku za slobodno crtanje. Kliknite [ ▼ ] na lijevoj strani ikone kako biste promijenili boju i debljinu crte olovke.
- 6  **Olovka za isticanje teksta**  
Prebacivanje na olovku za isticanje teksta kojom možete crtati prozirne crte. Kliknite [ ▼ ] na lijevoj strani ikone kako biste promijenili boju i debljinu crte olovke za isticanje teksta.
- 7  **Crna olovka**  
Prebacivanje na crnu olovku za slobodno crtanje. Kliknite na desnu stranu ikone kako biste crtali debele crte, odnosno kliknite lijevu stranu ikone kako biste crtali tanke crte.
- 8  **Crvena olovka**  
Prebacivanje na crvenu olovku za slobodno crtanje. Kliknite na desnu stranu ikone kako biste crtali debele crte, odnosno kliknite lijevu stranu ikone kako biste crtali tanke crte.
- 9  **Plava olovka**  
Prebacivanje na plavu olovku za slobodno crtanje. Kliknite na desnu stranu ikone kako biste crtali debele crte, odnosno kliknite lijevu stranu ikone kako biste crtali tanke crte.
- 10  **Brisalo**  
Prebacivanje na brisalo. Kliknite na desnu stranu ikone za brisanje širih područja, odnosno lijevu stranu ikone za brisanje tanjih područja.
- 11  **Oбриši zaslon**  
Brisanje sveg nacrtanog na prikazanoj stranici.

- 12  **Uvijek pokaži alatne trake**  
(To je nedostupno na prozoru prikazanom u Način rada s bijelom pločom za pisanje.)  
Alatna traka za crtanje uvijek se prikazuje.
- 13  **Odabrani alat**  
Prikazuje odabrani alat u olovka [  ] [  ] i dodir [  ] kao ikonu.  
(Prikazani sadržaj razlikuje se ovisno o korištenom modelu.)
- 14  **Zatvoriti**  
(To je nedostupno na prozoru prikazanom u Način rada s bijelom pločom za pisanje.)  
Zatvara Alatna traka za crtanje. Traka naredbi također je zatvorena tijekom Način rada s bilješkama.  
Alatna traka za crtanje možete ponovno prikazati odabirom kartice Alatna traka za crtanje [  ] na desnoj ili lijevoj strani zaslona.
- 15  **Unesi tekst**  
Promjena u način za unos teksta. Odaberite područje crtanja na kojem želite prikaz tekstualnog okvira.
- 16  **Ponovi poništeno**  
Poništavanje radnje poništavanja i vraćanje prethodnog stanja.

## Prilagodba i uređivanje oblika i slika

Moguća je prilagodba i uređivanje oblika, crta i umetnutih slika.

- Veće, Manje

Odaberite [  ] na Alatna traka za crtanje, odaberite objekt i zatim povucite točke za uvećanje ili umanjjenje.



Prilikom uvećavanja ili umanjivanja objekta prstima, odaberite objekt i zatim dodirnite dvije točke na objektu. Prilikom uvećavanja udaljujte prste kako biste razmaknuli dvije točke. Prilikom umanjivanja približavajte prste.

- Rotiranje

Odaberite [  ] na Alatna traka za crtanje, odaberite objekt i zatim rotirajte točke.

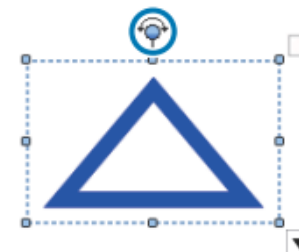

Prilikom rotiranja objekta prstima, odaberite objekt i zatim dodirnite dvije točke na objektu. Pomičite prste u smjeru u kojem želite rotirati objekt.



Prilikom odabira slike iscrtane crtama, svakako odaberite punu crtu.







KRUNICA

STABLO



LIST

PRAŠNICI



TUČAK



LATICA



Grada cveta:

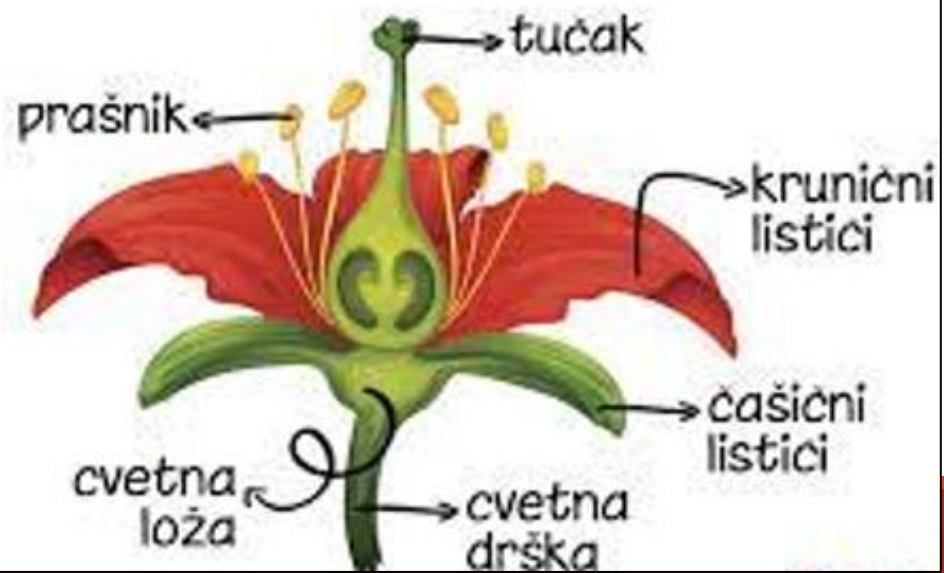



Strengthening Teaching Competences in Higher Education  
in Natural and Mathematical Sciences  
[www.tecomp.ni.ac.rs](http://www.tecomp.ni.ac.rs)

Co-funded by the  
Erasmus+ Programme  
of the European Union



# ХВАЛА НА ПАЖЊИ!



**Др Снежана Бранковић**  
**Природно-математички факултет Универзитет у**  
**Крагујевцу**

